

Universal 1U-2U Cable Management Arm

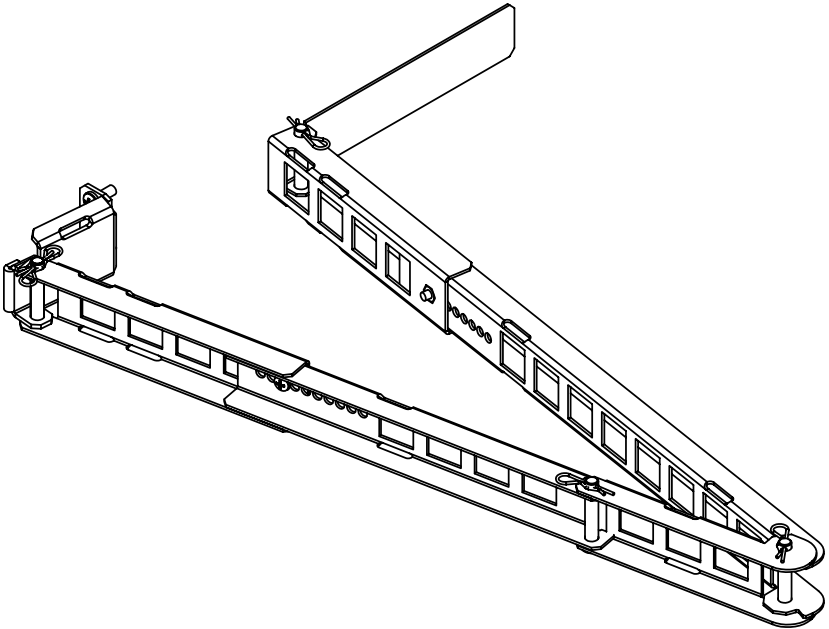

Installation Instructions

Kit P/N: 1UCMA-137

2UCMA-137

Kit Contents

Cable Management Arm

Hardware:

- (6) 12" Zip Ties
- (1) Velcro One-Wrap 50"
- (1) Plastic Lanyard 6"
- (1) Chassis Bracket with Adhesive

Rack Mount Hardware:

- (3) 12-24 Square Nuts
- (3) 10-32 Pan Head Screws, 3/4"
- (3) 12-24 Pan Head Screws, 3/4"
- (3) 12-24 Cage Nuts "Black"



Long
Rack Bracket



Short
Rack Bracket

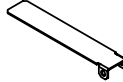

Chassis
Bracket

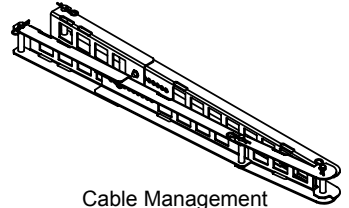

Cable Management
Arm (CMA)

Installation Instructions

- Step 1.** Select the Rack Bracket: Typical installations will use the Short Rack Bracket. The Long Rack Bracket is needed when the back of the server is near the rear mounting posts. If the Long Rack Bracket is needed, remove the Short Rack Bracket and attach the Long Rack Bracket using the same pin and retainer.

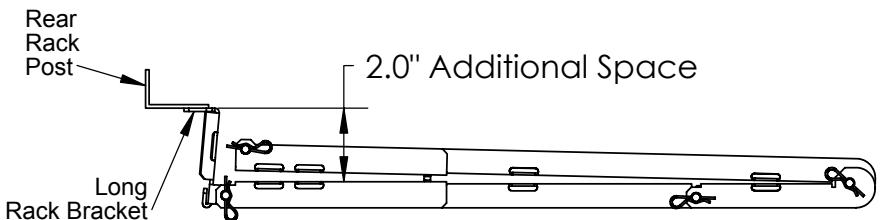
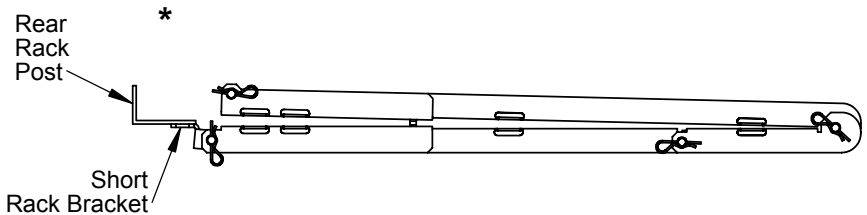

*** 1U Cable Management shown,
2U works identically**

Installation Instructions

- Step 2.** Attach the CMA to the Rack: The attachment of the CMA to your rack will vary based on your application. Rack Mount Hardware is provided for typical installations. Depending on the type of server and how the rail attaches to the rack, additional hardware may be required.

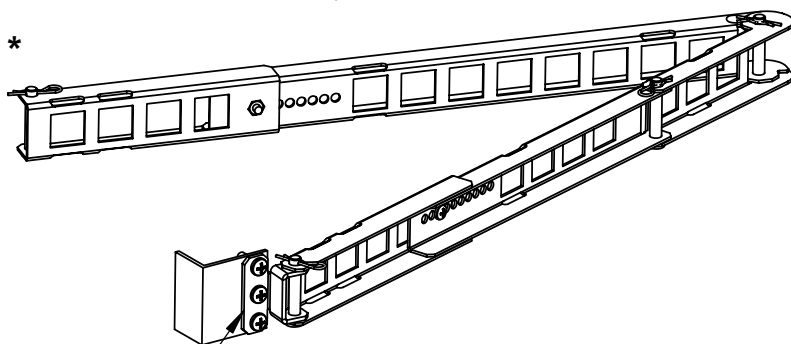

Short Rack Bracket

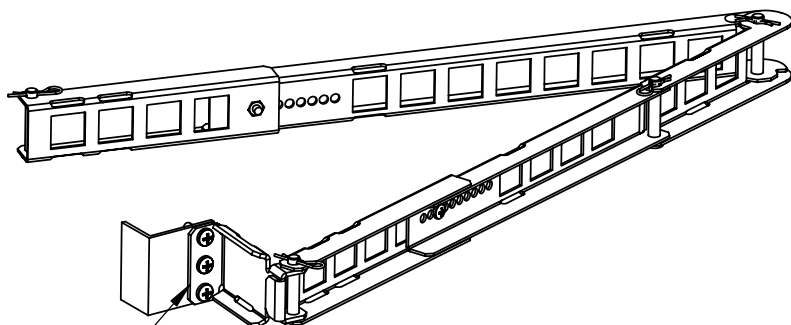

Long Rack Bracket

*** 1U Cable Management shown,
2U works identically**

Rack Mount Hardware

The Rack Hardware kit provides various screws and nuts for the four most common types of racks.

Square Hole Racks: Install Cage Nuts in appropriate positions. Attach with the larger 12-24 Screws.

12-24 Threaded Racks: Attach with the larger 12-24 Screws.

10-32 Threaded Racks: Attach with the smaller 10-32 Screws.

Round Hole Racks: (non-threaded) Attach with the larger 12-24 Screws and the square nuts.

Rack Hardware Kit

Step 3. Attaching the CMA to your server: There are four methods for linking the moveable end on the CMA to your server:

A) Route the cables from the chassis to the arm. Leave 2" - 4" between the box and the end of the arm. Tightly tie the cables to the arm with Zip-Ties.

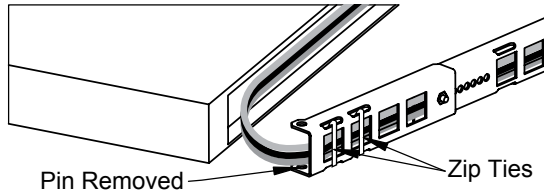

B) Loop the lanyard around a handle or other feature on the box.

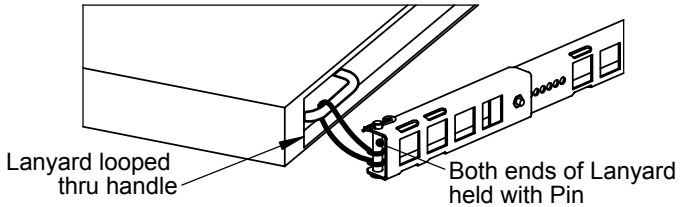

C) Attach the lanyard to a screw or hole on the box.

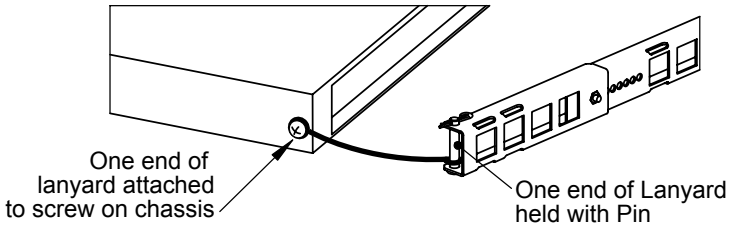

D) Adhere the Chassis Bracket to the side of the server.

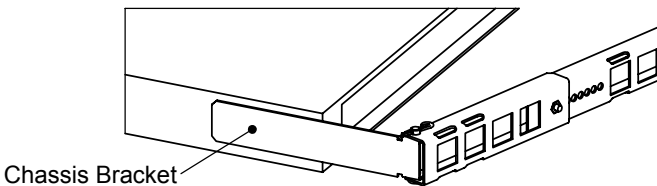

Warranty Statement

Innovation First, Inc. warrants our products against defects in material and workmanship for a period of one (1) year from the date of purchase. Innovation First, Inc. liability shall be limited to repairing or replacing, at our option, any defective product.